



Glass Fibre Reinforced Gypsum Panel System

User should check the validity of the Certificate by contacting Member Secretary, BMBA at BMTPC or the Holder of this Certificate.

Name and Address of Certificate Holder:
**M/s FACT – RCF Building Products Ltd.(FRBL)
FACT Cochin Division
Campus, Ambalamedu,
Kochi, Kerala-682303, India**

Performance Appraisal Certificate No.

PAC No **1009-S/2012**

Issue No. **01**

Date of Issue: **31.05.2012**



**Building Materials & Technology Promotion Council
Ministry of Housing & Urban Poverty Alleviation
Government of India
Core 5A, First Floor, India Habitat Centre,
Lodhi Road, New Delhi – 110 003**

Tel: +91-11-2463 8096, 2463 8097; Fax: +91-11-2464 2849

E-mail: bmtpc@del2.vsnl.net.in Web Site: <http://www.bmtpc.org>

PERFORMANCE APPRAISAL CERTIFICATE

FOR

GLASS FIBRE REINFORCED GYPSUM PANEL

ISSUED TO

M/S FRBL, COCHIN

STATUS OF PAC 1009-S/2012

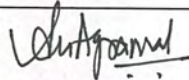
S.No	Issue No.	Date of Issue	Date of renewal	Amendment		Valid up to (Date)	Remarks	Signature of authorized signatory
				No.	Date			
1.	2.	3.	4.	5.	6.	7.	8.	9.
1	01	31-5-12				31-5-14		
							Dr. Shailesh Kr. Agarwal Chairman, TAC & Member Secretary, BMBA Building Materials and Technology Promotion Council Ministry of Housing & Urban Poverty Alleviation, (Govt of India) Core 5A, 1st Floor, India Habitat Centre, Lodhi Road, New Delhi-110 003	

PAC No. 1009-S/2012

Issue No. 01

Date of issue: 31.5.2012

CONTENTS

PART-1 CERTIFICATION.....	3
1-1 Certificate Holder	3
1-2 Description of Product	3
1-3 Assessment	4
1-4 Uses of the Product and its Limitations	4
1-5 Conditions of Certification	6
1-6 Certification	6
PART-II CERTIFICATE HOLDER'S TECHNICAL SPECIFICATION	6
II-1 Product specification.....	6
II-2 Technical Specifications.....	7
II-3 Selection and Installation	9
II-4 Maintenance requirements	10
II-5 Skills/ training needed for installation	10
II-6 Warranties provided by the PAC holder	10
II-7 Service provided by the PAC holder to the customer	10
PART-III BASIS OF ASSESSMENT AND BRIEF DESCRIPTION OF ASSESSMENT PROCEDURE	11
III-1 Assessment	11
III-2 Factory Inspection	11
III-3 Laboratory tests done for assessment	11
PART-IV STANDARD CONDITIONS	13
PART-V LIST OF STANDARDS AND CODES USED IN ASSESSMENT.....	15
CERTIFICATION	16
PART-VI ABBREVIATIONS	17
PERFORMANCE APPRAISAL CERTIFICATION SCHEME – A BRIEF.....	18
ANNEXURE	19

PART – I CERTIFICATION

I – 1 CERTIFICATE HOLDER:

**M/S FACT-RCF BUILDING
PRODUCTS Ltd**

I – 2 DESCRIPTION OF SYSTEM

I – 2.1 Name of the System– Glass Fibre Reinforced Gypsum Building Panel System

I -2.2 Brand Name: Rapidwall Panel

I – 2.3 File Reference – BMT/CPMT/PACs/FRBL/2012

I – 2.4 Brief Description –

Glass Fiber Reinforced Gypsum (GFRG) Panel branded as Rapidwall is a building panel product, made of calcined gypsum, plaster, reinforced with glass fibers, for Mass-scale building construction, was originally developed and used since 1990 in Australia.

The panel, manufactured to a thickness of 124mm under carefully controlled conditions to a length of 12 m and height of 3m, contains cavities that may be unfilled, partially filled or fully filled with reinforced concrete as per structural requirement. Experimental studies and research in Australia, China and India have shown that GFRG panels, suitably filled with plain reinforced concrete possesses substantial strength to act not only as load bearing elements but also as shear wall, capable of resisting lateral loads due to earthquake and wind. GFRG panel can also be used advantageously as in-fills (non-load bearing) in combination with RCC framed columns and beams (conventional framed construction of multi-storey building) without any restriction on number of stories micro-beams and RCC screed (acting on T-beam) can be used as floor/ roof slab.

Grade and Type- GFRG panel may be supplied in any of the following three grades :

- 1) Class 1- Water Resistant grade – panels that may be used for external walls, in wet areas and/or as floor and wall formwork for concrete filling;
- 2) Class 2 – General grade -- panels that may be used structurally or non-structurally in dry areas. These panels are generally unsuitable for use as wall or floor formwork; and
- 3) Class 3 – Partition grade – panels that may only be used as non-structural internal partition walls in dry areas only.

I-3 ASSESSMENT

I 3.1 Scope of Assessment

I-3.1.1 Scope of assessment included conformance of manufactured panel to the specified requirements for use in building construction as:

- i) Load bearing wall panel
- ii) Shear Wall
- iii) Floor/ roof slab

I-3.2 Basis of Assessment

Assessment of the suitability of panels manufactured at FRBL, Cochin as load bearing wall, shear wall, floor/ roof slab is based on

- i) Satisfactory test results of testing of the samples drawn from manufacturing line of FRBL plant for dimensions, weight, compressive strength, water absorption, flexural strength and fire resistant vis-à-vis requirements contained in the specification for Glass fiber Reinforced Gypsum Building Panel, BMBA-PC-3 2011(1)
- ii) Construction of the two room single apartment using the panels as wall unit and roof slabs construction.
- iii) GFRG/Rapidwall Building structural Design Manual, developed by IIT, Madras.
- iv) Quality Assurance scheme followed by the Certificate holder for process control.
- v) Construction Manual for Building using GFRG/ Rapidwall Panels.

I-4 USE OF THE GFRG PANELS AND LIMITATION

I-4.1 The panel may be used generally in the following ways:

- 1) As lightweight load bearing walling in building (single or double storey construction) upto two storey construction: the panel may be used with or without non-structural core filling such as insulation, sand polyurethane or lightweight concrete.
- 2) As high capacity vertical and shear load bearing structural walling in multi-storey construction: the panel core shall be filled with reinforced concrete suitably designed to resist the combined effect of lateral and gravity loading.
- 3) As partition infill wall in multi-storey framed building: Panel may also be filled suitably.
- 4) As Horizontal floor/ roof slabs with reinforced concrete micro beams and screed (T-beam action)
- 5) As pitched (sloped) roofing
- 6) As cladding for industrial building
- 7) As compound wall

I-4.2

Special Aspects of use:

- 1) The building to be constructed using GFRG panel manufactured in accordance with the specifications prescribed in this PAC shall be designed by Competent Structural Engineers on the basis of GFRG/ Rapidwall Building Structural Design Manual, developed by IIT, Madras. It is advisable to get design of important projects vetted by IIT Madras initially on mutually agreed terms.
- 2) Plumbing and Electrical services shall be governed by the provisions and details given in the Construction Manual developed by the PAC holder.
- 3) GFRG building systems should be constructed only with technical support or supervision by qualified engineers and builders, based on structural designs carried out to comply with prevailing standards; this is applicable even for low-rise and affordable mass housing to provide safety of structures. For this Construction Manual developed by the PAC holder shall be the guiding criteria.
- 4) It is strongly recommended that structural engineers and building designers associated with GFRG panel construction should be thoroughly familiar with the various structural aspects outlined in the Design Manual. It is also recommended that Architects and Construction Engineers who undertake GFRG/ Rapidwall building design and Construction gain familiarity with the properties and materials, characteristic of GFRG and its application and construction system.
- 5) PAC holder shall arrange training of structural engineers who may be involved in design and construction of structures using GFRG panels in association with IIT Madras, on mutually agreed terms.

I-4.3

Limitation of Use:

- i) Can not be used for wall with circular or higher curvature
- ii) Clear span shall be limited to 5m for residential buildings, for non residential buildings, the span shall be limited to as specified in Design Manual.

I – 4.4

Scope of Inspection – Scope of inspection included the verification of production, performance and testing facilities at the factory including competence of technical personnel and status of quality assurance in the factory.

I – 4.5

Manufacturing & test facilities – Manufacturing and test facilities available in the factory were found to be suitable to produce these panels as per the specifications. Testing equipments listed were also

verified and found to be in working condition.

- I – 4.6 Competence of Technical Personnel --** Persons involved in training were found to be well conversant with testing procedures required for the quality control of the product.
- I – 4.7 Experience in actual use –** A double storied building constructed near the campus of FEDO, Amalmedu using Rapidwall panels was inspected. It showed no distress & was found to be functioning satisfactorily.
- I – 5 CONDITIONS OF CERTIFICATION**
- I – 5.1 Technical conditions –**Raw materials and the finished panels shall conform to the requirements of the prescribed specifications.
- I – 5.2 Quality Assurance –** The Certificate Holder shall implement & maintain a quality assurance system in accordance with Scheme of Quality Assurance (SQA) given in the Annexure attached with this Certificate.
- I – 5.2.1** Structures using the panels shall be designed as per Clause I-4.2(1) and executed as per provisions of this PAC.
- I – 5.3 Handling of User Complaints**
- I – 5.3.1** The Certificate holder shall provide quick redressal to consumer/user complaints proved reasonable & genuine and within the conditions of warranty provided by it to customer/purchaser.
- I – 5.3.2** The Certificate holder shall implement the procedure included in the SQA. As part of PACS Certification he shall maintain data on such complaints with a view to assess the complaint satisfaction and suitable preventive measures taken.
- I – 6 CERTIFICATION**
- I – 6.1** On the basis of assessment given in Part III of this Certificate & subject to the conditions of certification, use & limitations set out in this Certificate and if selected, installed & maintained as set out in Part I & II of this Certificate, the panels covered by this Certificate are fit for use set out in the Scope of Assessment.

PART – II CERTIFICATE HOLDER’S TECHNICAL SPECIFICATIONS

II – 1 PRODUCT SPECIFICATION

II – 1.1 The PAC holder shall manufacture the panels in accordance with the requirements specified in the Specification for Glass Fiber Reinforced Gypsum Building Panel attached with this Certificate.

II – 2 TECHNICAL SPECIFICATIONS

II – 2.1 Raw Materials

- (i) Phosphogypsum – Shall be > 90% purity as CaSO₄
- (ii) Glass Roving – E glass shall be > 98% purity
- (iii) Ammonium Carbonate – Shall be of 99.14% purity as NH₄CO₃

II – 2.2 Manufacturing process

- Phosphogypsum which is a byproduct of phosphoric acid plant is calcined in calciner at 140-150⁰ C at the rate of 15MT/hr of calcined plaster. This calcined plaster is stored in product silo having capacity of 250MT.
- The plaster is then transferred to batch hopper by screw conveyors and through Entoleter in wall panel manufacturing area.
- This area consists of 6 casting tables having dimensions of 3m x 12m, one crab having mixer and glass roving delivery system is for delivering slurry and glass roving for three tables. The chemicals are added in water & mixed and then plaster is added & mixed to form slurry.
- One layer of slurry is laid on the table by the crab followed by a layer of glass roving. This glass roving is embedded in to the slurry with the help of screen roller.
- Another layer of slurry is poured followed by a layer of glass roving this layer is pushed inside the ribs with the help of temping bar. Finally a layer of glass roving is laid for the top face of the wall panel.
- After getting final Gilmore wall panel is lifted from the casting table to ACROBA frame and shifted to dryer for drying. The wall panel is dried at a temperature of 275⁰C for 60 minutes.
- After drying, the wall panel is either shifted to storage area or on the cutting table. The wall panel is cut as per dimensions supplied by the consumer and the cut pieces are transferred to stillages which are specially made for transporting wall panel.
- The liquid effluent generated during manufacturing process is recycled back in the system for manufacturing of new wall panels.
- The solid waste which is generated while manufacturing wall

panels is recycled back to the calciner after crushing and separating plaster & glass roving in recycle plant.

- The above system is a batch process. Six wall panels can be manufactured in eight hour shift per table. Similarly, 36 wall panels can be manufactured in eight hour shift with 6 tables.
- Flow diagram of the system showing the manufacturing process is attached herewith.

II – 2.3 Inspections & Testing shall be done at appropriate stages of manufacturing process. The inspected panels shall be stored & packed to ensure that no damage occurs during transportation. As part of quality assurance regular in process inspections shall be carried out by the trained personnel of the PAC holder.

II – 2.4 Construction & workmanship

(i) Rapidwall for rapid construction

Building shall be designed on the basis of Design Manual* by a qualified structural Engineer. As per the building plan and design, each wall panel shall be cut at the factory using an automated cutting saw. Door/window/ventilator and `openings for AC unit etc. shall also be cut and panels for every floor marked as per the building drawing. Panels are vertically loaded at the factory on stillages for transportation to the construction site on trucks. The stillages shall be placed at the construction site close to the foundation for erection using crane with required boom length for construction of low, medium and high rise buildings. Panels shall be erected over the RCC plinth beam and concrete is infilled from top. All the panels shall be erected as per the building plan by following the notation. Each panel shall be erected level and plumb and shall be supported by lateral props to keep the panel in level, plumb and secure in position. Embedded RCC lintels shall be provided wherever required by cutting open external flange. Reinforcement for lintels and RCC sunshades shall be provided with required shuttering and support.

*Copy of Design Manual shall be made available by the Certificate Holder, to the client involved for design & construction of building using the panels on requests.

(ii) Concrete infill

After inserting vertical steel reinforcement as per the structural design and clamps for wall corners are in place to keep the wall panels in perfect position, concrete having 12mm aggregate shall be poured from the top into the cavities using a small hose to go down at least 1.5 to 2m into the cavities for directly pumping the concrete from ready mixed concrete truck. For small building

construction, concrete can be poured manually using a funnel. Filling the panels with concrete shall be done in three layers of 1m height with an interval of 1 hour between each layer. There is no need to use vibrator because gravitational pressure acts to self compact the concrete inside the water tight cavities.

(iii) Embedded RCC tie beam all around at each floor/roof slab level

An embedded RCC tie beam is provided at each floor slab level as an essential requirement, web portion to required beam depth at top shall be cut and removed for placing horizontal reinforcement with stirrups and then concrete to be filled.

(iv) GFRG panel for floor/roof slab in combination with RCC

GFRG panel for floor/roof slab shall be cut to required size and marked with notation. First, wall joints, other cavities and horizontal RCC tie beams are in-filled with concrete; then wooden plank 0.3 to 0.45m wide shall be provided to room span between the walls with support wherever embedded micro beams are there and then roof panels shall be lifted by crane. Each roof panel shall be placed over the wall in such a way that there will be a gap of at least 40mm. This is to enable vertical rods to be placed continuously from floor to floor and provide monolithic RCC frame within Rapidwall. Wherever embedded micro-beams are there, top flanges of roof panel shall be cut leaving at least 25mm projection. Reinforcement and weld mesh is placed for micro beams and then concrete shall be poured for micro beams and RCC slab.

(v) Erection of wall panel and floor slab for upper floor

Vertical reinforcement of floor below shall be provided with extra length so as to protrude to 0.45m to serve as start up rods and lap length for upper floor. Once the wall panels are erected on the upper floor, vertical reinforcement rods, door/window frames fixed and RCC lintels shall be casted. Then concrete where required and joints shall be filled. Thereafter, RCC tie beams all around shall be concreted.

(vi) Water proofing

The PAC holder shall provide to the client details of water proofing treatment required at different levels of construction such as foundation, sunshade and flooring etc.

(vii) Finishing work

Once concreting of ground floor roof slab is completed, wooden

planks with support slabs shall be removed after 4th day. Finishing of internal walls and ceiling corners shall be done using wall putty by experienced POP plasterers. Simultaneously, electrical work, water supply and sanitary work, floor tiling, mosaic or marble works, staircase work etc. shall also be carried out for each upper floor.

II – 3 SELECTION & INSTALLATION

II – 3.1 The user/installer is responsible for proper selection and erection at site as per manufacturer's instructions.

II -- 3.2 **Choosing size and thickness** –Appropriate size of the panels shall be chosen to suit the requirements of the user.

II –3.3 **GFRG panel erection** –Methods of erection of GFRG Panel shall vary depending upon the use of the panels recommended . The method of erection of the panel is as follows:

- 1) Align the wall by marking with line dori, where wall is to be erected.
- 2) Then fix the hold fast (regular door frame hold fast of 150mm) by plumbing wall. Two nos. of hold fasts are required for each panel.
- 3) Simultaneously cut the pocket of electrical points & electrical conduits to be inserted inside cavity of Rapidwall.
- 4) Then erect the panel by supporting with props.
- 5) Fix electrical switch boxes.
- 6) Fix other panels same as per the above method up to required length
- 7) Check the plumb & line of the wall.
- 8) Fill the holdfast gap with concrete.
- 9) Finish the joints of two panels by fixing fiber tape with stucco as follow:
 - i) Make a slot of 8mm wide & 2mm deep at the joint of Rapidwall
 - ii) Fix the jointing fiber tape and finish the surface with stucco.
- 10) Joints of Rapidwall with RCC column/ beam shall be finished by stucco with reinforcing fiber of used cement bags.
- 11) Finish the gap around electrical points and between Rapidwall & slab/beam by stucco.

II – 4 Maintenance requirements

A proper maintenance guide shall be given by the PAC holder to the client. When building is to be repainted with fresh coat of paint after scraping existing paint, check for joint sealant, pipe joint, sun shade etc. and carry out required maintenance and apply primer before paint is applied.

II – 5 Skilled /Training needed for installation

Workers shall be trained/ oriented on handling of panel and its erection, support system, clamping system, infilling of reinforcement and concrete etc. with all required safety measures taken including heavy hats, protective shoes etc. PAC holder shall arrange training of workers, as required in this regard.

II--6 Guarantees/Warranties provided by the PAC Holder- PAC holder shall provide necessary guarantees/ warranties. A brochure giving relevant details and warrantee detail shall be made available to the client.

II – 7 Services provided by the PAC holder to the customer

In-house testing of panels at regular intervals as per the QCA requirement shall be ensured by RCF.

Part--III BASIS OF ASSESSMENT AND BRIEF DESCRIPTION OF ASSESSMENT PROCEDURE

III – 1 Assessment

III – 1.1 The assessment was done as per provisions of the standards listed in Part V of this Certificate

III – 1.2 The assessment is based on the results & reports of

- (i) Inspection of the factory
- (ii) Inspection of the test equipment used, test procedures followed and testing personnel involved in the laboratory of the factory
- (iii) Assessment of quality assurance procedures implemented in the factory
- (iv) Tests done in the factory on random samples of the panels taken by IO during inspection on the basis of performance characteristics given by the manufacturer
- (v) Tests got done in independent laboratories by the manufacturer
- (vi) Inspection of these panels in service

III – 2 Factory inspections

Inspection of manufacturing process was done. Firm has got necessary manufacturing machineries as per the process description given for manufacturing the panels. Routine testing of weight, water absorption and compressive strength are done. The firm is advised to establish complete testing facility for routine testing.

III – 3 Laboratory Tests done for assessment

III – 3.1 Testing of samples

III – 3.1.1 In Independent laboratory – The performance tests for these panels specified in relevant Standards and listed below have been got done on the samples of the panels in independent institute namely IIT Madras by the manufacturer. The samples conform to the tests as per the performance requirements and specifications given by the manufacturer.

Tests done in independent laboratory

S.No.	Parameters	Test Method	Requirement	Results Obtained
1.	Dimensions Length Height Thickness	BMBA PC-3:2011 Clause 10.4.2	12.02m 3.05m 124mm	Within specified tolerances
2.	Water Content	Clause 10.4.3	Less than 1%	Satisfactory
3.	Weight	Clause 10.4.4	40 kg/m ²	44.10 kg/m ²
4.	Water absorption	Clause 10.4.5	Max. 5% by weight	1.51% (Avg.)
5.	Compressive strength	Clause 10.4.6	Min. 160 kN/m	164.50 kN/m (Avg.)
6.	Flexural strength	Clause 10.4.7/10.4.8	Min. 2.1 kN/m	2.158 kN /m (Avg.)
7.	Fire resistance	Clause 10.4.10	4 hr rating withstood 700-1000°C	Satisfactory

PART-IV STANDARD CONDITIONS

This certificate holder shall satisfy the following conditions:

- IV-1** The certificate holder shall continue to have the product reviewed by BMBA.
- IV-2** The product shall be continued to be manufactured according to and in compliance with the manufacturing specifications and quality assurance measures which applied at the time of issue or revalidation of this certificate. The Scheme of Quality Assurance separately approved shall be followed.
- IV-3** The quality of the product shall be maintained by the certificate holder. Complete testing facilities shall be installed for in-process control.
- IV-4** The product user should install, use and maintain the product in accordance with the provisions in this Certificate.
- IV-5** This certificate does not cover uses of the product outside the scope of this appraisal.
- IV-6** The product is appraised against performance provisions contained in the standards listed in Part-V. Provisions of any subsequent revisions or provisions introduced after the date of the certificate do not apply.
- IV-7** Where reference is made in this Certificate to any Act of Parliament of India, Rules and Regulations made there under, statutes, specifications, codes of practice, standards etc. of the Bureau of Indian Standards or any other national standards body and the International Organization for Standardization (ISO), manufacturer's company standards, instruction/manual etc., it shall be construed as reference to such publications in the form in which they were in force on the date of grant of this Certificate (and indicated in Part V to this Certificate)
- IV-8** The certificate holder agrees to inform BMBA of their clients with details of construction on six monthly basis.
- IV-9** The certificate holder agrees to provide to BMBA feedback on the complaints received, the redressal provided, and the time taken to provide redressal on complaint to complaint basis as soon as redressal is provided. BMBA agrees to provide the certificate holder the user feedback received by it, if any.
- IV-10** If at any time during the validity period, PACH is unable to fulfill the conditions in his PAC, he should on his own initiative suspend using the PAC and notify Chairman, TAC the date from which he has suspended its use, the reason for suspension and the period by which he will be able to resume. He shall not resume without the prior permission of BMBA. He shall also inform, simultaneously, his agents, licensees, distributors, institutional, government, public sector buyers, other buyers and all those whom he has informed about his holding the PAC. He shall also

inform all those who buy his product(s) during the period of suspension. He shall provide to BMBA at the earliest the list of who have been so informed by him.

IV-11 In granting this Certificate, BMBA takes no position as to:

- (a) The presence or absence of patent or similar rights relating to the product;
- (b) The legal right of the Certificate holder to market, install or maintain the product;
- (c) The nature of individual installations of the product, including methods of workmanship.

IV-12 BMTPC and the Board of Agreement of BMTPC (BMBA) take no position relating to the holder of the Performance Appraisal Certificate (PACH) and the users of the Performance Appraisal Certificate (PAC) respecting the patent rights / copy rights asserted relating to the product / system / design / method of installation etc. covered by this PAC. Considerations relating to patent / copy rights are beyond the scope of the Performance Appraisal Certification Scheme (PACS) under which this PAC has been issued. PACH and users of this PAC are expressly advised that determination of the Claim / validity of any such patent rights / copy rights and the risk of infringement of such rights are entirely the responsibility of PACH on the one hand and that of the users on the other.

IV-13 It should be noted that any recommendations relating to the safe use of the product which are contained or referred to in this Certificate are the minimum standards required to be met with when the product is installed, used and maintained. They do not purport in any way to restate or cover all the requirements of related Acts such as the Factory Act, or of any other statutory or Common Law duties of care, or of any duty of care which exist at the date of this Certificate or in the future, nor is conformity with the provisions of this Certificate to be taken as satisfying the requirements of related Acts.

IV-14 In granting this Certificate, BMTPC and BMBA does not accept responsibility to any person or body for any loss or damage, including personal injury, arising as a direct or indirect result of the use of this product.

IV-15 The certificate holder indemnifies BMBA, its officers and officials involved in this assessment against any consequences of actions taken in good faith including contents of this certificate. The responsibility fully rests with the certificate holder and user of the product.

IV-16 The responsibility for conformity to conditions specified in this PAC lies with the manufacturer who is granted this PAC. The Board (BMBA) will only consider requests for modification or withdrawal of the PAC.

IV-17 The PAC holder shall not use this certificate for legal defense in cases against him or for legal claims he may make from others.



Chairman TAC & for and on behalf of
Member Secretary, BMBA

Dr. Shailesh K. Agarwal
Chairman, TAC
& Member Secretary, BMBA
Building Materials and Technology Promotion Council
Ministry of Housing & Urban Poverty Alleviation, (Govt. of India)
Core 5A, 1st Floor, India Habitat Centre, Lodhi Road,
New Delhi-110 003

Place: New Delhi

Date of issue 31/5/12

PART – V LIST OF STANDARDS & CODES USED IN ASSESSMENT

Part - V.1 Standards - These Standards are referred for carrying out particular tests only and do not specify the requirement for the whole product as such.

Part –V.1.1 BMBA PC-3: 2011 – Specifications for Glass Fibre Reinforced Gypsum panel

Part – V.2 Company Standards of the PAC holder – The branded design & specifications of the raw materials and finished product are as submitted by the manufacturer. The PAC holder has to make available the company standards to the consumers according to which testing have been done.

CERTIFICATION

In the opinion of Building Materials & Technology Promotion Council's Board of Agreement (BMBA), **Glass Fibre Reinforced Gypsum Panel** bearing the mark manufactured by M/s FACT-RCF Building Products Ltd Ltd is satisfactory if used as set out above in the text of the Certificate. This Certificate **PAC No.1009-S/2012** is awarded to M/s **FACT-RCF Building Products Ltd.**

The period of validity of this Certificate is as shown on Page 1 of this PAC. This Certificate consists of pages 1 to 21.



On behalf of BMTPC Board of Agreement

New Delhi, India

Place

Date **31-5-12**

Ud Agrawal

Chairman, Technical Assessment Committee (TAC) of
BMBA & Member Secretary, BMTPC Board of Agreement (BMBA)
Under Ministry of Housing and Urban Poverty Alleviation, Government of
India

Dr. Shailesh Kr. Agarwal
Chairman, TAC
& Member Secretary, BMBA
Building Materials and Technology Promotion Council
Ministry of Housing & Urban Poverty Alleviation, (Govt. of India)
Core 5A, 1st Floor, India Habitat Centre, Lodhi Road,
New Delhi-110 003

Abbreviations

BMBA	Board of Agreement of BMTPC
BMTPC	Building Materials and Technology Promotion Council
CPWD	Central Public Works Department
ED	Executive Director of BMTPC
IO	Inspecting Officer
MS	Member Secretary of BBA
PAC	Performance Appraisal Certificate
PACH	PAC Holder
PACS	Performance Appraisal Certification Scheme
SQA	Scheme of Quality Assurance
TAC	Technical Assessment Committee (of BMBA)

Performance Appraisal Certification Scheme - A Brief

Building Materials & Technology Promotion Council (BMTPC) was set up by the Government of India as a body under the Ministry of Housing & Urban Poverty Alleviation to serve as an apex body to provide interdisciplinary platform to promote development and use of innovative building materials and technologies laying special emphasis on sustainable growth, environmental friendliness and protection, use of industrial, agricultural, mining and mineral wastes, cost saving, energy saving etc. without diminishing needs of safety, durability and comfort to the occupants of buildings using newly developed materials and technologies.

During the years government, public and private sector organizations independently or under the aegis of BMTPC have developed several new materials and technologies. With liberalization of the economy several such materials and technologies are being imported.

However, benefits of such developments have not been realized in full measure as understandably the ultimate users are reluctant to put them to full use for want of information and data to enable them to make informed choice.

In order to help the user in this regard and derive the envisaged social and economic benefits the Ministry of Housing & Urban Poverty Alleviation has instituted a scheme called Performance Appraisal Certification Scheme (PACS) under which a Performance Appraisal Certificate (PAC) is issued covering new materials and technologies. PAC provides after due investigation, tests and assessments, amongst other things information to the user to make informed choice.

To make the PACS transparent and authentic it is administered through a Technical Assessment Committee (TAC) and the BMTPC Board of Agreement (BMBA) in which scientific, technological, academic, professional organizations and industry interests are represented.

The Government of India has vested the authority for the operation of the Scheme with BMTPC through Gazette Notification No. 1-16011/5/99 H-II in the Gazette of India No. 49 dated 4th December, 1999.

Builders and construction agencies in the Government, public and private sectors can help serve the economic, development and environmental causes for which the people and Government stand committed by giving preference to materials and technologies which have earned Performance Appraisal Certificates.

Further information on PACS can be obtained from the website: www.bmtpc.org

BUILDING MATERIALS & TECHNOLOGY PROMOTION COUNCIL**QUALITY ASSURANCE PLAN FOR GFRG PANEL**

S.No.	Parameters to be inspected	Requirement Specified	Test Method	Frequency of Testing
A. Rapidwall/GFRG Panel				
1.	Visual Appearance	Shall be free from defects like cracks, corrugations, ripples, stains, pockmarks, loose corners etc.	As per BMBA PC-3:2011 Clause10.4.1	Once in every ten panels
2.	Overall Dimensional Tolerances	Length & height shall be within tolerance limit of $\pm 3\text{mm}$ & thickness $+3\text{mm}$ to 0mm	Clause10.4.2	Once in every fifty panels
3.	External Skin thickness tolerance	Shall be $\pm 3\text{mm}$ (General /Water resistance grade) Min 8mm Partition grade	Clause10.4.2	Once in every fifty panels
4.	Internal Rib thickness tolerance	Shall be $\pm 2\text{mm}$ (General /Water resistance grade) Shall be $\pm 5\text{mm}$ (Partition grade)	Clause10.4.2	Once in every fifty panels
5.	Cavity Width & Depth Tolerance	Shall be $\pm 3\text{mm}$ (General / Water resistance grade) Shall be $\pm 7\text{mm}$ (Partition grade)	Clause10.4.2	Once in every fifty panels
6.	Unevenness	Shall be less than 1mm (Side A) Shall be less than 3mm (Side B)	Clause10.4.2	Once in every fifty panels
7.	Panel weight	Shall be $40 \text{ Kg/m}^2 \pm 6\%$ (Class 1 & 2) Shall be $40 \text{ Kg/mm}^2 \pm 15\%$ (Class 3)	Clause10.4.4	Once in every fifty panels
8.	Water Content	Shall be less than 1% (measured immediately after drying process)	Clause 10.4.3	Once in every fifty panels
9.	Water Absorption Rate	Shall be less than 5% by weight (after 24 hrs of immersion in water)	Clause 10.4.5	Once in every fifty panels
10.	Vertical Load bearing capacity (Compressive strength)	Shall be more than 160 kN/m (General / Water resistance grade) Shall be more than 90 kN/m (Partition grade)	Clause 10.4.6	Once in every fifty panels
11.	Out of plane Flexural capacity (Flexural strength)	Shall be more than 2.1 kN/m (General /Water resistance grade) Shall be more than 1.3 kN/m (Partition grade)	Clause 10.4.7/ Clause 10.4.8	Once in every fifty panels
12.	“ U” Value	Shall be $2.85 \text{ W/M}^2 \text{ C}$	IS3346:1980	Once in a year or when the composition changes and initially at the time of approval
13.	Thermal Conductivity (K)	Shall be 0.617 W/m C	IS3346:1980	
14.	Sound transmission	Shall be 40 (STC)	ISO 140-3:1996	

15.	Durability i. wetting & drying ii. Salt spray	Average compressive strength shall not be less than 7.52 N/mm ² Shall not suffer any apparent damage after 20 cycles	Clause 10.4.9	Once in a year or when the composition changes and initially at the time of approval
16.	Fire Resistance	Shall withstand 700-1000 ⁰ C after 4hr	Clause 10.4.10	
B. Raw Materials				
1.	Calcined Gypsum	i. Shall be more than 90% as Calcium Sulphate ii. Combined moisture shall not be more than 6.2%	As per Company Standard	i. Once in a day ii. Once in a shift
2.	Ammonium Carbonate	Shall not be less than 99.14% as purity	As per Company Standard	Once on delivery at site
3.	Glass Roving	These raw materials are performance based. Test Certificates provided by the manufacturers are verified at the time of delivery.		
4.	BS-94 M			
5.	Retarder D-50			

Specification for BMBA PC-3:2011 Glass Fibre Reinforced Gypsum Building Panel

Table of Contents

1.	SCOPE	23
2.	APPLICATION	23
3.	REFERENCED DOCUMENTS	23
4.	DEFINITIONS	23
4.1.	STANDARD GFRG PANEL	23
4.2.	WATER RESISTANT GFRG PANEL	24
4.3.	EXTERNAL SKIN	24
4.4.	INTERNAL RIB	24
4.5.	CAVITY	25
4.6.	PANEL LENGTH	25
4.7.	PANEL THICKNESS	25
4.8.	PANEL HEIGHT	25
4.9.	A AND B SIDE	25
5.	GRADE CLASSIFICATION	25
6.	STANDARD DIMENSIONS	25
6.1.	PRODUCT CODING	26
7.	PERFORMANCE REQUIREMENTS	26
7.1.	APPEARANCE REQUIREMENT	26
7.2.	DIMENSIONAL TOLERANCES	26
7.3.	WATER CONTENT	27
7.4.	PANEL WEIGHT	28
7.5.	WATER ABSORPTION RATE	28
7.6.	VERTICAL LOAD BEARING CAPACITY	28
7.7.	OUT-OF-PLANE FLEXURAL CAPACITY	28
8.	MARKING	28
9.	QUALITY SYSTEM AND QUALITY CONTROL PROCEDURES	29
10.	QUALITY PROCEDURE BY STATISTICAL SAMPLING	29
10.1.	GENERAL	29
10.2.	SAMPLING	29
10.2.1.	<i>Sampling for Routine Tests</i>	29
10.2.2.	<i>Sampling for Flexural Tests</i>	31
10.3.	CRITERIA OF COMPLIANCE	31
10.4.	TEST METHODS	32
10.4.1.	<i>Appearance Inspection</i>	32
10.4.2.	<i>Measurement of Dimensions and Flatness</i>	32
10.4.2.1	<i>Apparatus</i>	32

10.4.2.2	Measurements	32
10.4.3.	<i>Measurement of Water Content</i>	33
10.4.3.1	Apparatus	33
10.4.3.2	Test procedure	34
10.4.3.3	Calculation of Results	34
10.4.4.	<i>Measurement of Density</i>	34
10.4.4.1	Apparatus	34
10.4.4.2	Test procedure	34
10.4.4.3	Calculation of Results	34
10.4.5.	<i>Measurement of Water Absorption Rate</i>	35
10.4.5.1	Apparatus	35
10.4.5.2	Test procedure.....	35
10.4.5.3	Calculation of Results	35
10.4.6.	<i>Measurement of Vertical Load-bearing Capacity</i>	35
10.4.6.1	Apparatus	36
10.4.6.2	Test procedure.....	36
10.4.6.3	Calculation of results	36
10.4.7.	<i>Flexural Bending Test</i>	36
10.4.7.1	Apparatus	37
10.4.7.2	Test procedure.....	38
10.4.7.3	Calculation of results	38
10.4.8.	<i>Alternative Flexural Bending Test</i>	39
10.4.8.1	Apparatus	40
10.4.8.2	Test procedure.....	40
10.4.8.3	Calculation of results	41
10.4.9	<i>Durability Test</i>	41
10.4.9.1	Wetting and drying test	41
10.4.9.2	Salt spray test	41
10.4.10	<i>Fire Resistance Test</i>	41
10.5.	TEST REPORT	42
11.	CUTTING, HANDLING, STORAGE AND DELIVERY	42
11.1.	CUTTING	42
11.2.	HANDLING	42
11.3.	STACKING	42
11.4.	PROTECTION FROM WEATHER	43
11.5.	DELIVERY	43

Specifications for Glass Fibre Reinforced Gypsum (GFRG) Building Panel

1 SCOPE

This document forms the product specification for manufactured GFRG panels designed for use in the construction industry for walling, ceilings, suspended floor formwork and partitions. The specified technical and mechanical property requirements refer to the finished product, that is, the final manufactured GFRG panel dried and ready for installation. Specified also is the quality control procedure and the associated mechanical tests necessary to ensure an acceptable quality of the finished GFRG panel product.

2 APPLICATION

This specification is intended for use by licensed manufacturers of GFRG to ensure a uniform, quality controlled global product suitable for its intended purpose. The details of this document also assists the end users, such as engineers, architects and builders, both in their designs using GFRG[®] and in specifying the physical properties of the GFRG panel in their contract documents.

3 REFERENCED DOCUMENTS

The following documents are referred to in this specification: -

- Report by IIT, Madras on Testing of GFRG panel dt 29th March, 2012
- GFRG/Rapidwall Building Structural Design Manual, IIT Madras
- ISO 9004.1 Quality Management and Quality System Elements, Part 1: *Guidelines*;

4 DEFINITIONS

For the purpose of this specification the following definitions apply: -

4.1 Standard GFRG Panel

GFRG panel is a factory manufactured walling product used in the construction industry to provide habitable enclosures for residential, commercial and industrial buildings. The 124mm thick hollow-core panels are machine-made using formulated gypsum-plaster reinforced with chopped glass-fibre. A typical cross-section and isotropic view of the wall panel is shown in Fig.1.

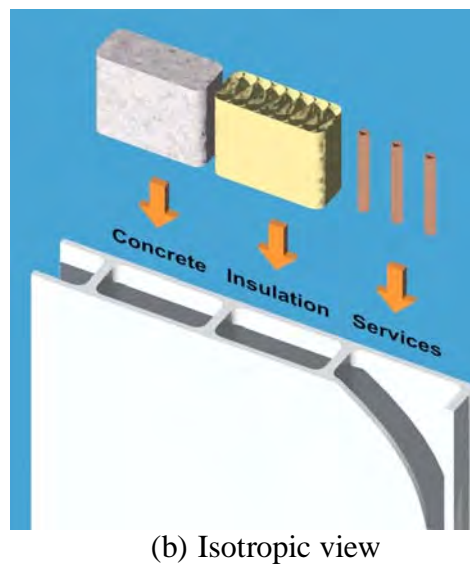
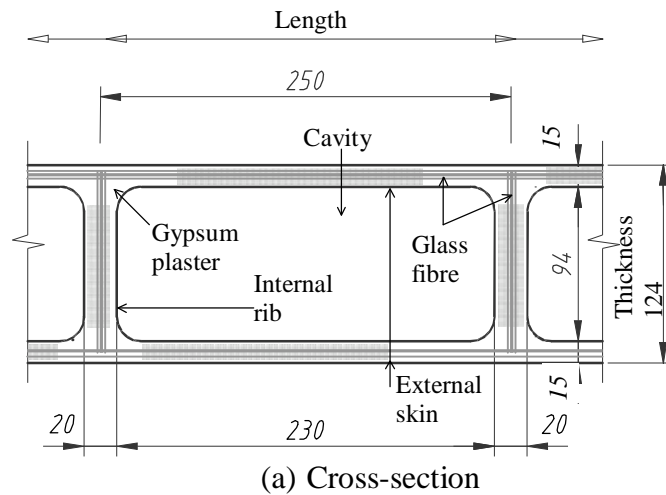

Fig.1 Standard GFRG panel

4.2 Water Resistant GFRG Panel

Water resistant GFRG panels are the same as ordinary GFRG panels in appearance. However the ingredients of the water resistant GFRG are modified specifically to provide water resistance when used externally or in wet areas such as bathrooms or laundries, etc.

4.3 External Skin

The two 13mm thick faces making up the panel are collectively defined as external skins as shown in Fig.1.

4.4 Internal Rib

The 20mm thick ribs inside the panel connecting the two external skins are called internal ribs as shown in Fig.1.

4.5 Cavity

The internal hollow cores inside the panel are called the *cavity* as shown in Fig.1.

4.6 Panel Length

The panel length is the maximum horizontal dimension of a single wall without vertical joint as indicated in Fig.1.

4.7 Panel Thickness

The panel thickness is the distance between the external faces of the two external skins, as shown in Fig.1.

4.8 Panel Height

The panel height is the maximum vertical dimension of a single wall without a horizontal joint.

4.9 A and B Side

The smoother side of the GFRG panel cast against the machine bed in the manufacturing process is called the A side. The B side is screeded and is relatively rougher than A side.

5 GRADE CLASSIFICATION

GFRG panel is supplied in three grade classifications:-

- 1). Class 1 - Water Resistant grade – panels that can be used for external walls, in wet areas and/or as floor and wall formwork for concrete filling;
- 2). Class 2 - General grade – GFRG panels that can be used structurally or non-structurally in dry areas. These panels are generally unsuitable for use as wall or floor formwork; and
- 3). Class 3 - Partition grade – GFRG panels that can only be used as non-structural internal partition walls in dry only areas.

6 STANDARD DIMENSIONS

The current nominal manufactured dimensions of each GFRG panel are: -

- Length 12,020 mm
- Height 3050 mm, and
- Thickness 124 mm

6.1 Product Coding

GFRG panels are coded using the following convention:-

GFRG TS- L × H × Date and place of manufacture

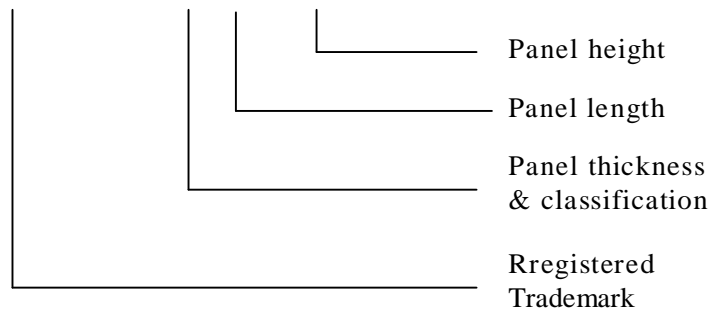

Where panel type is indicated as 'G' for general grade, 'W' for water resistant grade or 'P' for partition grade. For example a Water resistant 1 grade panel made in RCF, Trombay plant in Chembur , Mumbai 21st Feb 2010 is coded as: - **GFRG 124G-12X3-21FEB10/TROMBAY**

7 PERFORMANCE REQUIREMENTS

7.1 Appearance

The two external faces of GFRG panels should be free from defects such as corrugations, ripples, pockmarks, stains, loose corners, cracks or any other defects which would adversely affect a painted decorative surface finishes.

It is a requirement that paint can be directly applied to the A-side of GFRG without the need for extensive rendering or plastering. The quality of finish on the B-side of the panel can be controlled by the operation of the final screeding in the manufacturing process. The appearance requirements on the B-side are usually decided through negotiation between the manufacturer and its client. However, the minimum requirements for the B-side are that a 3.5mm texture coating or a trowelled-on coating will cover all the defects.

7.2 Dimensional Tolerances

The manufactured dimensional tolerances for a full sized GFRG panel shall satisfy Tables 1 and 2:-

Table 1. Overall Dimensional Tolerance

Length	Height	Thickness
Nominal length ±3mm	Nominal height ±3mm	Nominal thickness +3 to -0 mm

Table 2 Cross-sectional Dimensional Tolerance

Panel Classification	External Skin Thickness	Internal Rib Thickness	Cavity Width	Cavity Depth
General Grade & Water Resistant Grade	Nominal Thickness ±3	Nominal Thickness ±2	Nominal Width ±4	Nominal Depth ±3
Partition Grade	Minimum 8	Nominal Thickness ±5	Nominal Width ±7	Nominal Depth ±7

The flatness of the panel shall satisfy the following: -

- The maximum local unevenness of protruding or recessing beles than 1mm on the A side and 3mm on the B side, as shown in Fig.2(a); and
- For the overall curvature of the surface the deviation of any point on the panel face from a 2.5m straight edge shall not exceed $k=3\text{mm}$ in any part of the panel and in both of the two orthogonal directions, as shown in Fig.2(b)&(c).

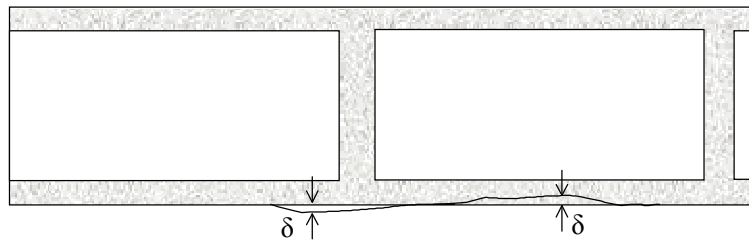

(a) Local unevenness

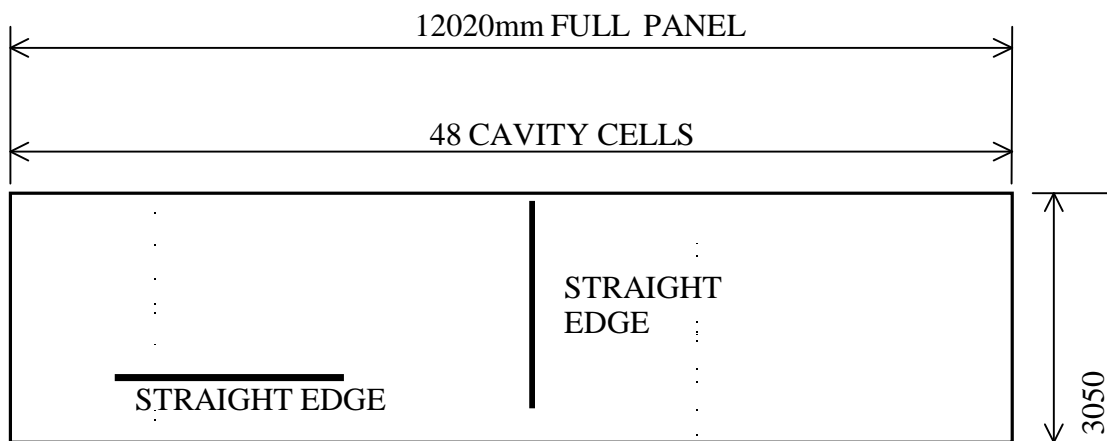

(b) Measurement of curvature in both directions

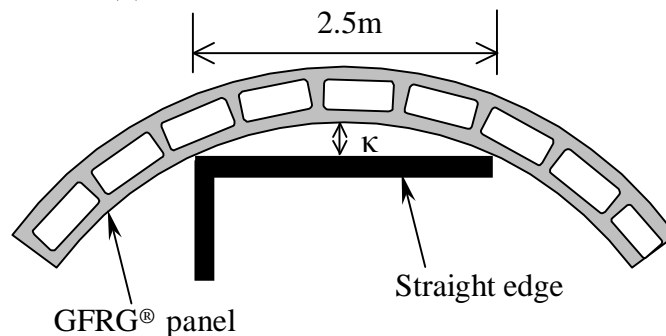

(c) Overall curvature

Fig. 2 Measurement of flatness

7.3. Water Content

The water content of panels measured immediately after the drying process (without moisture intake after drying) shall be less than 1% when tested in accordance with Clause 10.4.3.

The maximum acceptable water content after production is referred to in Section 7.5.

7.4 Panel Weight

The weight of the dried and empty hollow core GFRG panel shall satisfy Table 3:-

Table 3 Empty Panel Weight

Panel Classification (mm)	Nominal Weight (kg/m ²)	Tolerance %
Class 1, 124 mm thick	40	±6%
Class 2, 124 mm thick	40	±6%
Class 3, 124 mm thick	40	±15%

7.5 Water Absorption Rate

The water absorption rate for water resistant grade GFRG panels shall not be greater than 5% by weight after 24 hours of immersion in water when tested in accordance with Clause 10.4.5. No test is needed for other grades of GFRG panels.

7.6 Vertical Load Bearing Capacity

When tested in accordance with Clause 10.4.6, the cross-sectional compression strength of the panel shall satisfy the minimum requirements as given in Table 4.

Table 4 Acceptance criteria for compression strength

Minimum compression strength (kN/m)	
General or water resistant grade	Partition grade
160	90

7.7 Out-of-Plane Flexural Capacity

When tested in accordance with Clause 10.4.7 or 10.4.8, the out-of-plane flexural strength of the panel shall satisfy the minimum requirements as given in Table 5.

Table 5 Acceptance criteria for flexural strength

Minimum Flexural Strength per meter width	
General or Water Resistant Grade	Partition Grade
2.1 kNm	1.3 kNm

8 MARKING

Each manufactured GFRG panel shall be clearly marked with the following particulars:

- Product code in accordance with Clause 6.1;
- The manufacturer's name, address and trademark;
- Quality checked mark and identification of the checker; and
- Signs for packaging and transportation.

9 QUALITY SYSTEM AND QUALITY CONTROL PROCEDURES

Quality of the finished product is assured by a proper quality control system, it is needed to demonstrate the compliance with this specification and to supply products that conform to the full requirements of this specification. Generally, one of the following four quality procedures shall be adopted:-

- Evaluation by means of statistical sampling;
- The use of a product certification scheme;
- Assurance using the acceptability of quality system; and
-

For reference a procedure for statistical sampling is provided in Clause 10 of this specification.

10 QUALITY PROCEDURE BY STATISTICAL SAMPLING

10.1. General

Sampling and the establishment of a sampling plan should be carried out in accordance with Clause 10.2

10.2 Sampling

10.2.1. Sampling for Routine Tests

Three GFRG panels should be randomly selected from a batch of panels for tests described in Sections 10.4.1 to 10.4.6. Grouping of panels to form a batch shall follow the following rules: -

- 1). Every 500 panels of same grade classification form a batch, when there is no variation in mix design, ingredient materials, manufacturing conditions, and dryer conditions;
- 2). Two different grade classifications is into two different batches even when the number of panels in a batch is less than 500;
- 3). When the ingredients of gypsum, glass fibre, water and any other additives changes, new batch should be formed whenever such a change takes place. The same principal of forming a different batch applies when any other change is made in the manufacturing and drying process such as change of recipes or any other activity that may affect the property or quality of the finished panels; and
- 4). When significant variations exist in the manufacturing process that may affect the quality or properties of the panels, such as significant variation in the quality of plaster, batch is formed with a much smaller number of panels depending on the magnitude and extent of variations. Forming batch is on daily (or shift) basis in such kind of situations, i.e. panels produced in the same day (or shift) are considered as a batch.

Three test sample plates (520×580) are to be cut from each selected panel. The positions for cutting these three test plates are shown in Fig.3. Two different test specimens are to be cut from each test plate in accordance with the layout of Fig.4. The specimens shall be machine cut to the dimensions with a tolerance of not more than ± 2 mm.

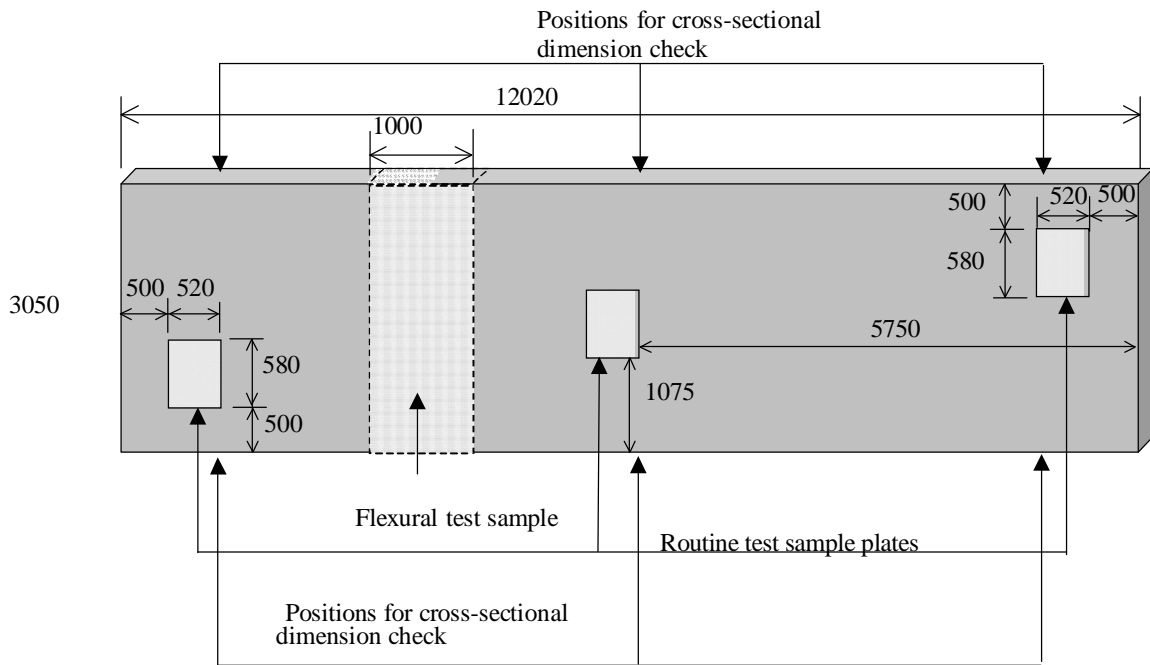

Fig.3 Positions of sampling

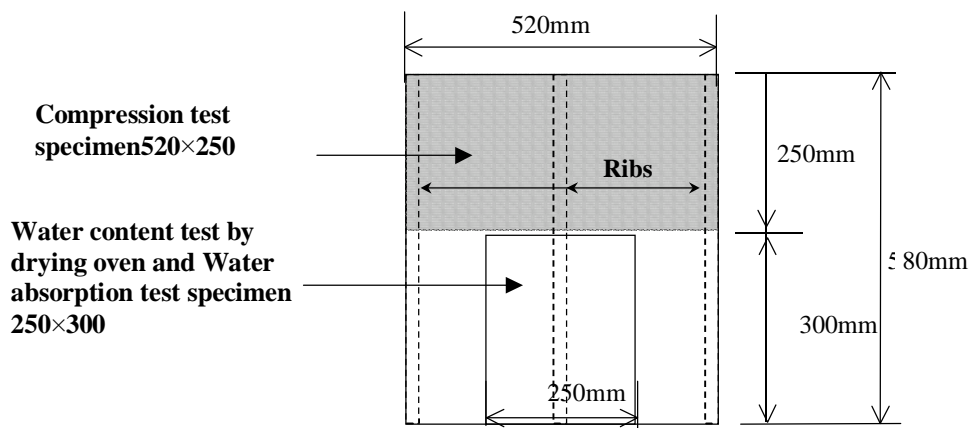

Fig.4 Detailed dimensions of test specimens

10.2.2. Sampling for Flexural Tests

The flexural strength of a panel largely depends on the quality, quantity and distribution of the glass-fibers in the panel. The flexural strength test may be conducted over a much longer interval and when any variation (such as quality, quantity or distribution) in glass-fibre takes place in the manufacturing process. One set of flexural tests consisting of three test specimens shall be conducted on one cluster of panels. Panels are grouped as one cluster if they are:

- 1). Made in the same six-month period of time when nothing changes in the manufacturing process; or
- 2). Made with a same batch of glass fiber. When an old batch of glass-fibre is used up and a new batch of glass-fibre is used for production, the panels made with new batch of glass fiber are considered as a new cluster. Any other change that is made to the glass fiber such as change of supply source, change of brand, change of quantity or quality of glass fiber, change of fiber strand length and means of distributing fiber, etc. shall make a different cluster of panel.

The three test specimens shall be cut from three different panels selected randomly from the same cluster. Specimen shall be cut at least one meter away from the vertical sides of the panel and shall be cut in such a way as shown in Fig.3 and Fig.5.

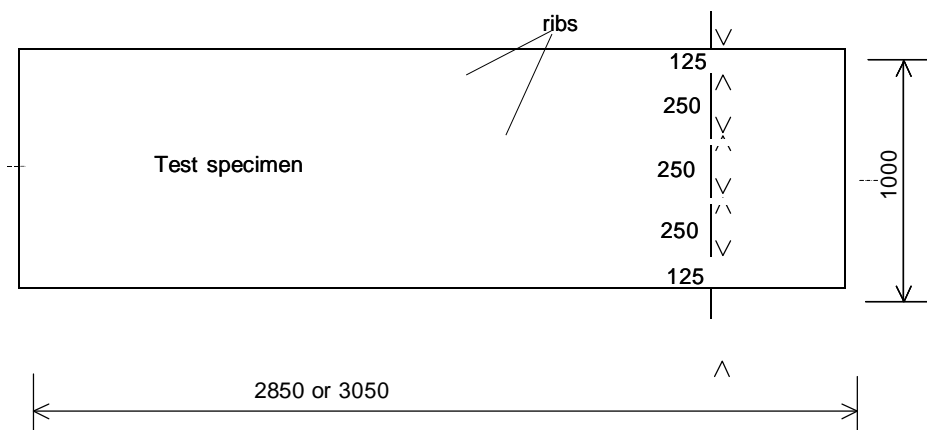

Fig. 5 Plan view of flexural test specimen

10.3 Criteria of Compliance

The batch or cluster of panels is deemed to satisfy the performance requirements of Clause 7 if all the test specimens selected in accordance with Clause 10.2 pass all the tests described in Clause 10.4. Otherwise it is considered to be non-compliant.

Panels that do not comply with the requirements for partition grade must not be used for building purposes and shall be destroyed. Panels that do not satisfy the general grade or water resistant grade may be downgraded to partition grade if they pass the specification for partition grade.

It is generally recommended that the samples be representative of the quality of all the panels in the same batch or cluster. In other words, the whole patch or cluster of panel fails the quality check and cannot be used if the samples fail any of the tests of Clause 10.4. However, if it is judged that the failed sample does not represent the quality of the whole batch of panel, and the manufacturer intends to use some or any panel in that batch

or cluster, then all the tests in Clause 10.4 shall be repeated to that batch or cluster such that the quality of the panels are proved. An acceptable way of repeated tests is that the number of test panels is doubled and all the repeated tests pass the performance requirements.

Only the panels that pass all the quality checks can be marked as quality checked.

10.4 Test Methods

Laboratories that undertake the tests shall generally satisfy AS ISO/IEC17025-1999: *General Requirements for the Competence of Testing and Calibration Laboratories*. Test equipment and devices shall satisfy the relevant requirements and be calibrated regularly to a local or international standard.

10.4.1. Appearance Inspection

Every finished panel shall be visually inspected in accordance with Clause 7.1.

10.4.2. Measurement of Dimensions and Flatness

The overall and cross-sectional dimensions as well as flatness shall be measured from the selected test panel (selected in accordance with Clause 10.2.1) to satisfy Clause 7.2 in any part of the panel.

10.4.2.1 Apparatus

The tools used for measurements shall satisfy the following requirements:-

- 1). The overall panel dimensions of length, height and thickness shall be measured to accuracy within 1.0mm; and
- 2). The other dimensions shall be measured to within 0.5mm.

10.4.2.2 Measurement

The length of the panel shall be measured at the positions of 1d, 2e and 3f; and the height of the panel shall be measured at the positions of a4, b5 and c6, as shown in Fig.6a. The thickness of the panel shall be measured at the 12 positions of 1 to 6 and a to f.

As shown in Fig.3, the cross-sectional dimensions shall be measured at six different positions of a, b, c, 4, 5, and 6, as shown in Fig.6a. Six separate measurements shall be taken at each of the above six positions, as shown in Fig.6b.

The flatness shall be checked at the positions of a2a22, a22b2, b2b22, b22c2, a4, b5 and c6.

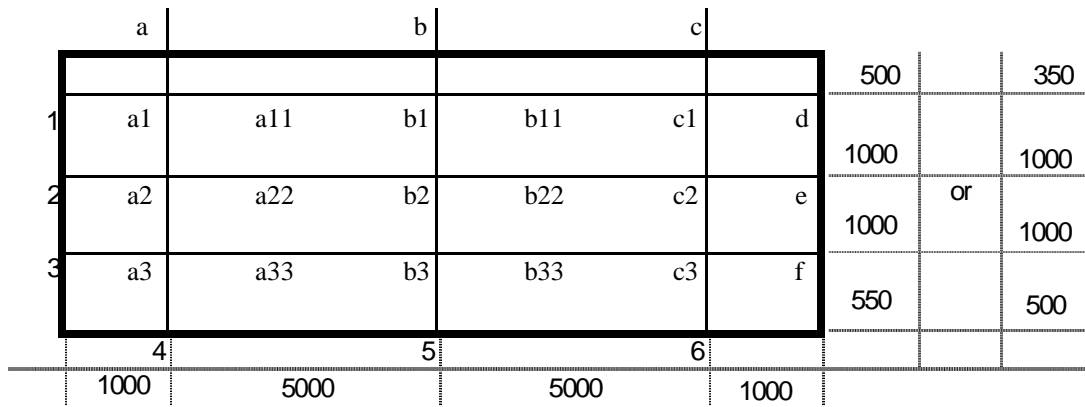

(a) Positions of overall dimension measurements

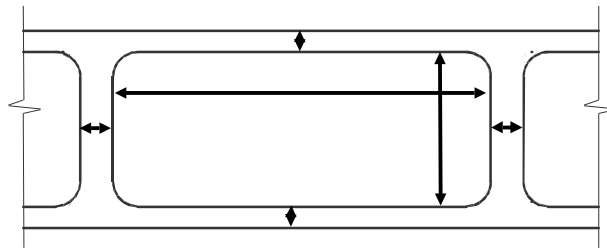

(b) Cross-sectional measurement points

Fig.6 Dimensional measurements

10.4.3. Measurement of Water Content

The water content shall be tested for the selected panels against Clause 7.3. Sampling of the test specimen shall be made in accordance with Clause 10.2.1. Do not treat the edges and surfaces of the specimens nor damage the specimens.

This test measures the loss of water of the specimen after drying in a standard oven. It is combined with the measurement of density and water absorption tests. Should the samples after conditioning take up moisture then the panel was over cooked (calcined) in the dryer and fails the test.

10.4.3.1 Apparatus

Air circulating oven: The net space available inside the drying oven shall not be less than 200×300×360. The oven shall have a temperature control at $40 \pm 2^\circ\text{C}$ and a humidity control at $50 \pm 2\%$.

Balance or scale: with a capacity of 5kg and an accuracy of 0.5g.

10.4.3.2 Test Procedure

- 1). Weigh each original specimen and record their weights;
- 2). Condition the specimen (or specimens) to constant weights, within 0.1% of the dried weight, at a temperature of $40\pm 2^{\circ}\text{C}$, in an atmosphere having a relative humidity of $50\pm 2\%$. This can be done by drying the specimen for 24 hours initially and weighing the specimen; then drying for another 4 hours each time and weighing the specimen until the difference of the two consecutive weights of the specimen is with 0.1% of the dried weight; and
- 3). Weigh the dried weight w of each specimen to within 0.5g.

10.4.3.3 Calculation of Results

The weight loss of the individual specimen in percent with respect to its dried weight w is the water content of the specimen.

10.4.4. Measurement of Density

Density of the panel shall be measured from the specimens immediately after the water content tests and before water absorption tests. Care shall be taken to prevent damaging the specimens in the measurement so that it does not affect the water absorption test.

10.4.4.1 Apparatus

Right-angle ruler: with an accuracy of within 1 mm.

10.4.4.2 Test procedure

Take the following measurements from each specimen:-

- The four dimensions as shown in Fig.7 measured to within 1mm, where $H1$ and $H2$ are the lengths of the two vertical sides, respectively, and $B1$ and $B2$ are the horizontal dimensions that is perpendicular to the vertical side measured with a right-angle ruler.

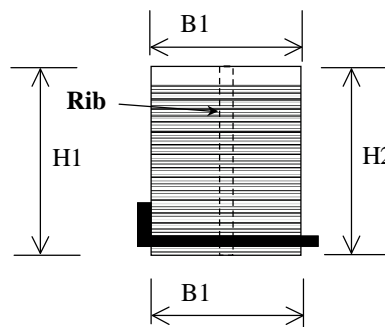

Fig.7 Dimensions for density measurement

10.4.4.3 Calculation of results

The density ρ (weight per surface area) of a specimen is calculated by

$$\rho = \frac{w}{\frac{H1 + H2}{2} \times \frac{B1 + B2}{2}}$$

where w is the weight of the specimen measured at step 3 of 10.4.3.2 and dimensions $H1$, $H2$, $B1$ and $B2$ are shown in Fig.7.

10.4.5. Measurement of Water Absorption Rate

The specimens tested for density is immediately used for water absorption rate.

10.4.5.1 Apparatus

Balance: same as 10.4.3.1.

Water bath or container: enough room to immerse the three specimens and keep them separated and elevated from the bottom of the bath with minimum spaces of 25mm.

10.4.5.2 Test procedure

- 1). Immerse the specimens flat in a bath of water at a constant temperature of $21 \pm 0.5^\circ\text{C}$ with a head of 25 mm of water over the top of the sample. The sample should be positioned in the water bath elevated one inch above its base;
- 2). Remove the specimens from the bath after 24 hours of immersion, wipe excess water from the surfaces and edges of the specimens and weigh immediately to within 0.5g.

10.4.5.3 Calculation of results

The percentage of weight gain with respect to the dried weight of each specimen calculated is the water absorption rate.

10.4.6. Measurement of Vertical Load-bearing Capacity

The test specimen as sampled in accordance with Clause 10.2.1 is shown in Fig.8 and the test set up is shown in Fig.9, where a universal compression test machine shall be used.

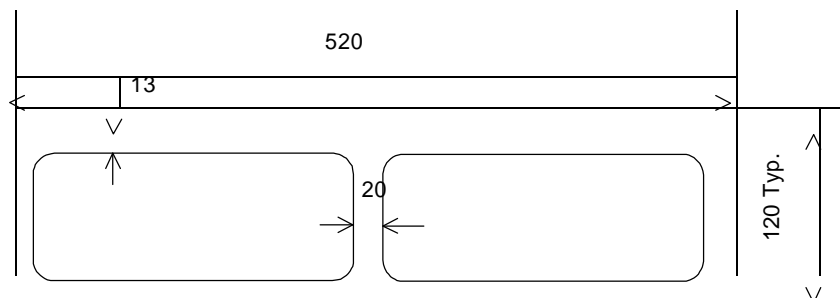

Fig.8 Cross-section of compression test specimen

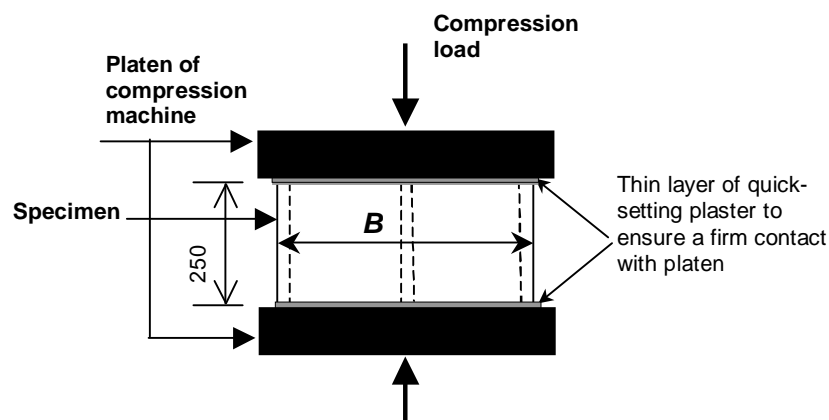

Fig.9 Compression test set up (Elevation)

10.4.6.1 Apparatus

Universal compression machine: the test machine shall be calibrated

10.4.6.2 Test procedure

- 1). Measurement of Dimension – the width B of the test specimen is measured at the waist of the specimen as shown in Fig.9. The measurement shall be taken on both the front face and the back face of the specimen and an average value used;
- 2). Placing of Specimen – the test specimen shall be placed at the centre of the platen on the test machine. Under no circumstance should any part of the specimen be placed outside the perimeter of the platen of the test machine;
- 3). Capping-the top and bottom faces of the test specimen shall be capped with a thin layer of quick-setting plaster (such as dental paste) to ensure firm and uniform contact with the platen. The strength of the applied plaster shall not be lower than that of the test specimen at the time of testing;
- 4). Loading – Apply the compression load gradually in a rate not greater than 10kN per minute until it reaches the peak load and then drops at least 20% off the peak load. The maximum applied load (peak load) F indicated by the testing machine shall be recorded.

10.4.6.3 Calculation of results

The unit strength of a specimen is reported as $p = \frac{F}{B}$ in a unit of kN/m, where F is the peak load, in kilo newtons, and B is the width in meter at the waist of the specimen.

10.4.7 Flexural Bending Test

The flexural test set up is shown in Fig.10.

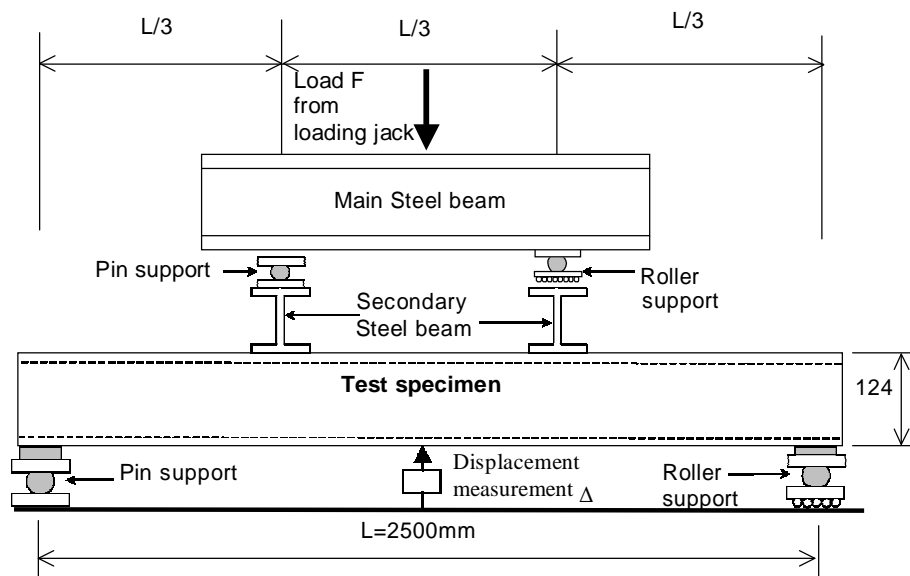

Fig.10 Flexural test set up

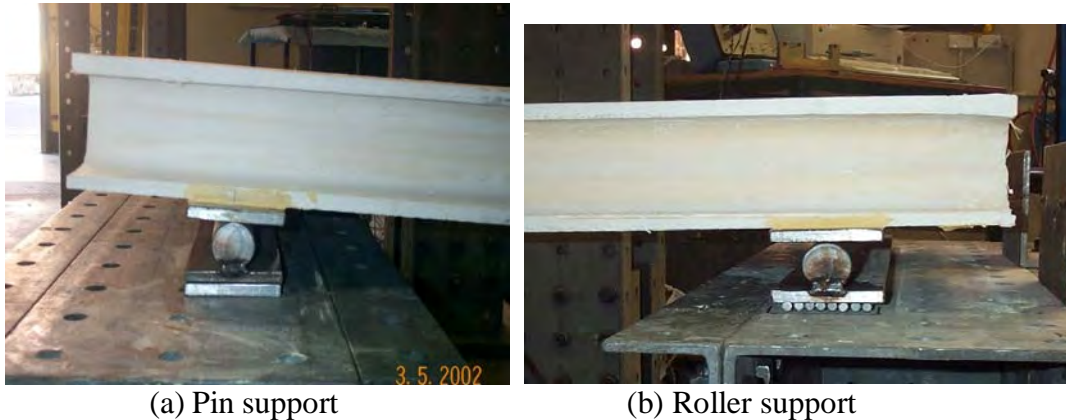

Fig.11 Method of supporting test specimen

10.4.7.1 Apparatus

As the specimen is one meter wide, it is important for the load and reaction force from the supports to be distributed evenly along the width of the specimen. The point load from a load jack is applied to a main distribution beam that then distributes the load equally to two secondary distribution beams. The load is finally transmitted from the secondary distribution beams to the top face of the test specimen as an evenly distributed line load.

The minimum ultimate flexural strength of the main distribution beam shall be 10kNm. The secondary distribution beam shall be 1000mm long with a minimum flexural rigidity EI of 5×10^{11} N/mm².

To ensure a good contact and even distribution of load, a thin layer of quick-setting plaster (such as dental paste) shall be applied between the bottom face of the secondary beams and the contact surface of the specimen.

The specimen shall be supported firmly with one pin support and one roller support as illustrated in Fig.11. The pin support is composed of two steel plates of 1000mm long \times 100mm wide \times minimum 10mm thick and a 1m long steel roller bar with a minimum diameter of 30mm. The steel bar is fixed to the bottom plate (such as by welding) and the top plate just sit on top of the bar to ensure free rotation. The roller support shown in Fig.11(b) is similar to the pin support except that some smaller steel roller bars of about 10mm diameter and 1000mm long are provided underneath the bottom steel plate to ensure both free rotation and longitudinal movement.

The loading jack shall have a minimum load capacity of 20kN. The displacement transducer shall have a minimum travel distance of 100mm.

The measurement or data acquisition involves both the applied load measured from the load cell and displacement from the displacement transducer at the mid-span. The accuracy of measurements shall be within 0.1kN for load and 0.5mm for displacement.

For tests in China, guidelines for the test apparatus and methodology shall follow GB 50152-92: National standard for tests of concrete structures.

10.4.7.2 Test procedure

- 1). Mark the positions of support line (centre line position of the roller bar) on the bottom of the specimen, and load line (centre line position of the secondary distribution beam) on the top of the test specimen;
- 2). Set up the pin and roller supports;
- 3). Apply a thin layer of quick-setting plaster on top of the supporting steel plates and then place the test specimen on top of the two supports. Waite a few minutes for the plaster to set;
- 4). Apply a layer quick-setting plaster on top of the test specimen at the position of the secondary distribution beams and place the secondary distribution beams in position. Allow the plaster to set;
- 5). Set up the rest of the loading system (main distribution beam and its support, etc.) and loading jack;
- 6). Place the displacement transducer under the test specimen at the mid-span. A piece of small plate (about 20mm×20mm×2mmthick) shall be glued onto the tip of the transducer to prevent it from going into a crack if the crack happens to occur at the position of the displacement measurement point;
- 7). Load the jack under displacement control in a strain rate of not greater than 5mm/minute until the load passes the peak and drops at least 50% off its peak load;
- 8). In the mean time of applying loading, record the test data at sufficient number of test points to produce a load vs. displacement curve (as illustrated in Fig.12). An automatic data acquisition system is recommended that can record the complete test curve automatically. If manual record is used, one data point (a pair of load and displacement readings) shall be taken at a displacement increment of not more than 1.5mm.

10.4.7.3 Calculation of results

The maximum moment capacity of a specimen is given by

$$M_u = \frac{1}{8}wL^2 + \frac{1}{6}(F + S) \times L$$

Where

w = the unit weight of the panel which is typically 0.4kN/m²;

F = the first peak load from the load vs. displacement curve as explained in more detail below, in kN;

S = the weight of the load distribution system including the main and secondary distribution beams, in kN; and

L = the span which is 2.5m.

The first peak load is the applied load at which the first major crack occurs (usually accompanied with a clear sound of breaking). Two typical cases to identify the first peak load are illustrated in Fig.12. This first peak load may not be the maximum load as shown in Fig.12(b).

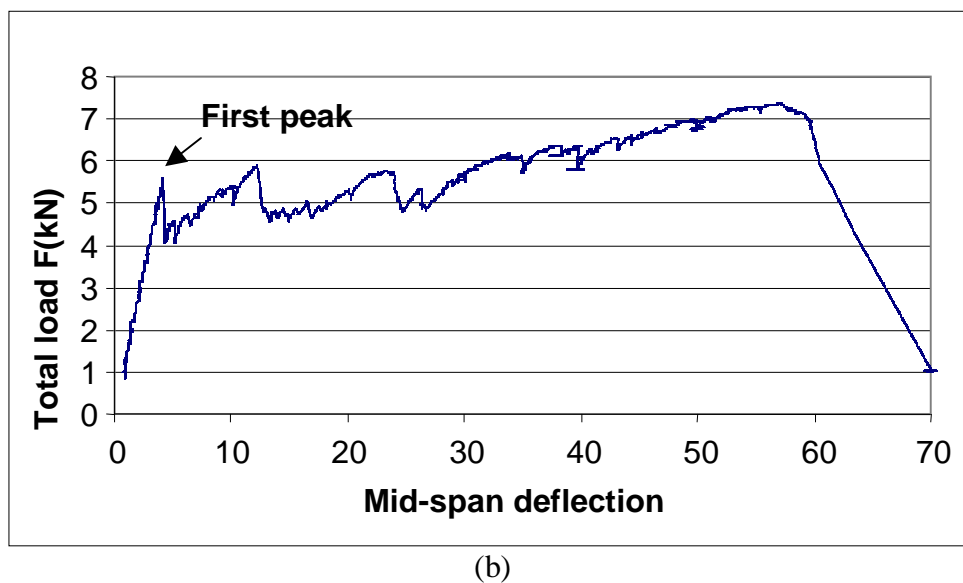
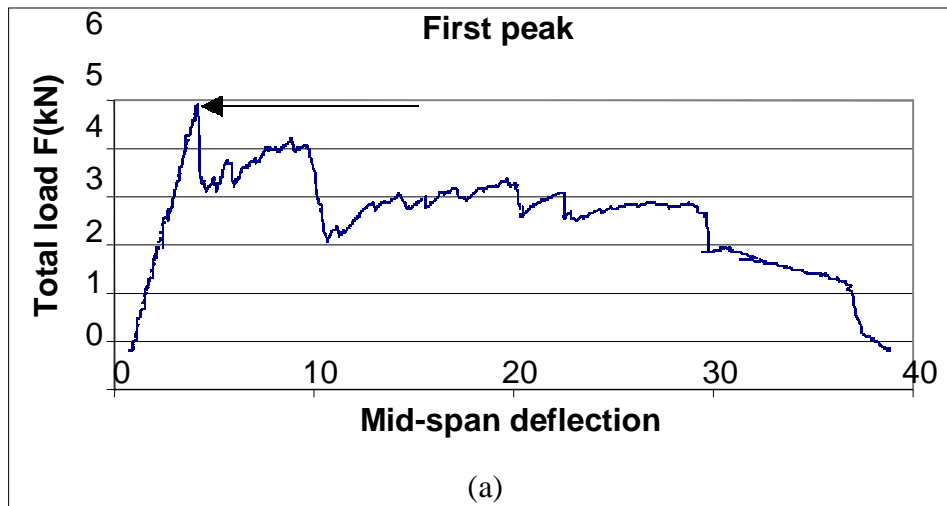

Fig.12. Typical out-of-plane bending test results

10.4.8 Alternative Flexural Bending Test

When the test frame and equipment required for the test as described in Section 10.4.7 are not available, the test provided in this section can be used as an alternative for the flexural bending test. The test set up is shown in Fig.13. Blocks of weight are used as load in this test instead of a loading jack.

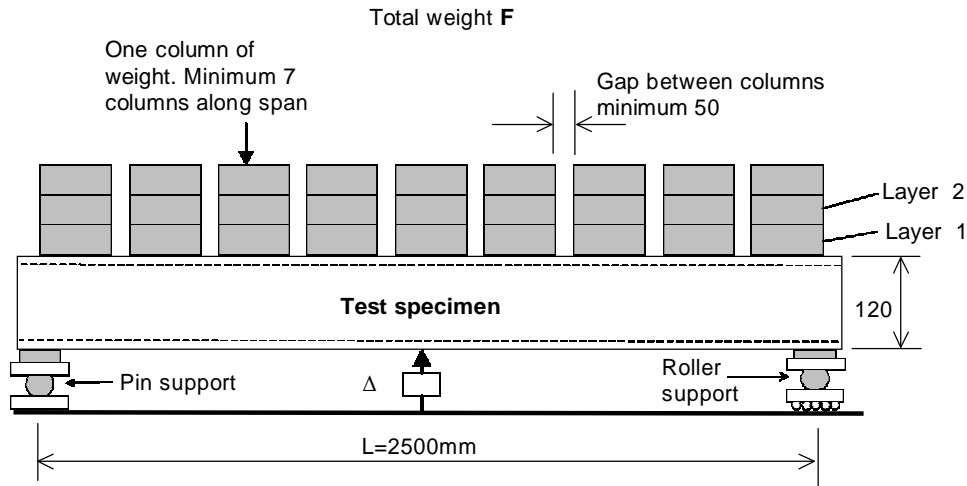

Fig.13 Alternative flexural test set up

10.4.8.1 Apparatus

The supporting systems of the test specimen and the displacement measurement transducer are the same as that described in Section 10.4.7.

All the weight blocks shall have an equal size and weight and be calibrated to an accuracy of within $\pm 1.0\%$ of the weight. The maximum weight of each block is generally required to be less than 10kg in order to have enough number of blocks to provide an even distribution of load on top of the specimen (in an area of 2500×1000), unless it can be shown that the heavier blocks will not adversely affect the even distribution of load. The size of the blocks shall also be restricted such that at least 7 columns of weight with a minimum gap of 50mm between columns can be distributed evenly along the span of the specimen, as shown in Fig.13.

For tests in China, guidelines for the weights can be found in GB 50152-92.

10.4.8.2 Test procedure

- 1). Mark the positions of support line (centre line position of the roller bar) on the bottom of the specimen;
- 2). Set up the pin and roller supports;
- 3). Apply a thin layer of quick-setting plaster on top of the supporting steel plates and then place the test specimen on top of the two supports. Waite a few minutes for the plaster to set;
- 4). Place the displacement transducer under the test specimen at the mid-span. A piece of small plate (about $20\text{mm} \times 20\text{mm} \times 2\text{mm}$ thick) shall be glued onto the tip of the transducer to prevent it from going into a crack if the crack happens to occur at the position of the displacement measurement point;
- 5). Put the weight blocks row by row, column by column and layer by layer on to the specimen as shown in Fig.13, starting from the mid span of the specimen and ensuring the even distribution of weights on the whole surface area of 2500×1000 ;
- 6). In the mean time of applying loading, record the test data at sufficient number of test points to produce a load vs. displacement curve (as illustrated in Fig.12). One

data point (a pair of load and displacement readings) shall be taken at a displacement increment of not more than 1.5mm.

10.4.8.3 Calculation of results

The maximum moment capacity of a specimen is given by

$$M_u = \frac{1}{8}(w + f)L^2$$

Where

w = the unit weight of the panel which is typically 0.4kN/m²;

$f = F/L$, F in kN is the first peak load (total weight) from the load vs. displacement curve as explained in Section 10.4.7.3; and

L = the span which is 2.5m.

The first peak load may not occur exactly at a time when a whole layer of load is applied. In that case, the load distribution at failure is not uniform and the maximum moment shall be calculated based on the actual distribution of the load.

10.4.9 Durability Test

10.4.9.1 Wetting and drying test

Put the panels through 20 cycles of wetting and drying at room temperature of 30⁰C. Each cycle consist of 24 hours of wetting followed by 24 hours of drying.

Measure the average compressive strength at the end of 20 cycles.

10.4.9.2 Salt spray test

Embed a 12mm dia,250mm reinforcing rod in the concrete filled in cavity. After 7 days curing, hung the same in a salt spray chamber for 2 weeks.

Observe any apparent damage to the panel and to the reinforcement.

10.4.10 Fire Resistance test

The fire resistance test on GFRG panel (Rapidwall) shall be conducted using a blow torch (burning kerosene as fuel). The blue flame temperature shall be measured and shall be in the range of 700⁰ C to 1000⁰C. The blower tip of the blow torch shall be kept at a distance of about 50 mm from one face of the building panel (size 300 x 300 x 124 mm) so that the blue flame shall directly hit the panel continuously. The panel shall be exposed to such a state for continuation duration of 4 hours. The other face of the panel shall be pasted with a thermocouple to monitor the temperature continuously.

Record the temperatures (⁰C) at 30 minutes interval during the test period of 4 hours for the hollow GFRG panel and the GFRG panel filled with M20 concrete the results.

At the end of the test, no damage or cracks should be observed beyond the spot where he flame was directly hitting the face of the panel.

10.5 Test Report

The following shall be reported from a test:

- 1). Type or name of the test;
- 2). Test date, name and venue of the laboratory, and the person who performed the test;
- 3). Product code and other identifications of sample;
- 4). Test results and any observation or comment in relation to either the test sample or the performance of the test;
- 5). Reference to the test method used, e.g. test method as described by Clause 10.4.7 of this specification;
- 6). Reference to the calibration certificate for equipment used, the calibration authority and expiry date of the certificate; and
- 7). Such other information contained in the records as may be requested.

11 CUTTING, HANDLING, STORAGE AND DELIVERY

This part of specification is only applicable within the factory before delivering to end-users. For the transport and storage of panel outside the factory, reference shall be made to specification for transport, storage and installation.

11.1 Cutting

Cutting shall be made with specific machine and impact tools such as hammer shall not be used for cutting or removing part of the panel. All cutting shall be made in accordance with the drawings and requirements provided by the client. Generally the following requirements are applicable: -

- 1). Tolerance to be ± 1 mm;
- 2). Openings to be partially cut in the factory, leaving about 100mm at the corner to be cut after installation of the panel;
- 3). Damage to corners shall be limited to within 10mm×10mm; and
- 4). Metal closure studs (C channels) are fitted to the edges of a panel immediately after cutting.

11.2. Handling

Handling of panel shall be made with specific machinery. Movement of panel shall be reasonably slow and care shall be taken to prevent undue sagging, cracking or damage to the panel especially at the sides, edges and corners. The damaged panel or part of the panel must not be used and shall be removed and destroyed. The RBS Friction Lifting Jaws must not be used in the factory as every rib in the GFRG panel can be clamped only once.

11.3 Stacking

GFRG panels shall be neatly stacked to avoid panel distortion, damage or moisture ingress. This can be achieved by stacking vertically on support extending the full length of the panel or a firm, clean and flat surface not susceptible to moisture. It shall also be kept free of any dirt, oil or other foreign matter.

When vertically stacked in open air, panels shall be protected from collapse caused by strong wind. A good practice is stacking panels inside a Stillage with its stabiliser legs extended.

11.4 Protection from Weather

All panels shall be kept dry preferably by being stored inside a building and under cover. Where it is necessary to store the panels outside, it shall be stacked off the ground in accordance with Clause 11.3.

11.5 Delivery

GFRG panels shall be packed and loaded on specifically designed stillage and delivered by suitable trucks. Extreme care must be taken in loading, transportation and unloading to ensure the safety and protection of the panels from damage due to collision or collapse of the panels. Care shall be exercised to avoid exceeding the maximum allowable height of vehicles applicable to a specific road in a specific area.

All general grade panels shall be protected from rain with a plastic membrane. Protection fro rain for water resistant grade panels is generally not required.